

The Midnight Loop

*An Experimental
Small Transmitting Loop
~ Theory & Practice ~*

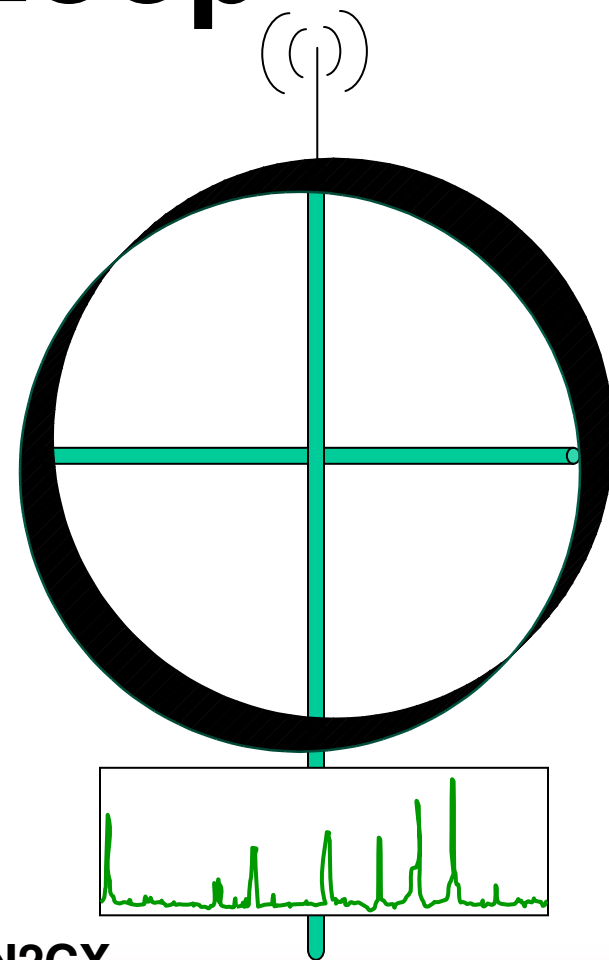

G. Heron, N2APB & J. Everhart, N2CX

Massachusetts QRP Convention 2010

CONTENTS

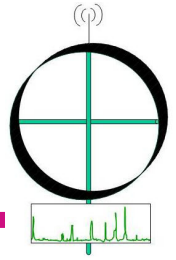

1. **Overview**: *Why a New Approach?*
2. **Theory**: *Novel Characteristics*
3. **Practice**: *The Prototype*
4. **Demo**: *Live and/or Video*
5. **Next Steps**: *Refine and Automate*
6. **Appendix**: *Supporting Material*

Overview

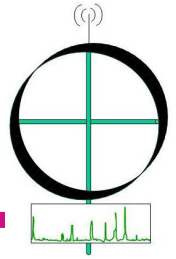

Fascination with STLs

- directivity, selectivity, noise reduction

Common limitations today:

- surface area, narrow BW
- tuning, materials & construction, efficiency

This presentation ...

- Is not a tutorial on “conventional” STL design
- We will immediately focus on problems of current designs
- And present experimental methods for improving state-of-the-art STL antennas

Radiation Pattern

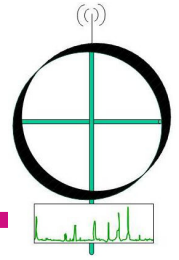

It's like a doughnut ...

- Vertically oriented loop gives radiation at all vertical angles, a figure-8 pattern when viewed from above including NVIS through Low angle radiation.
- Best for low end of HF even when only several feet above ground
- When oriented horizontally it radiates in a circle at all azimuth angles with a null at high vertical angles.
- Best at the upper end of the HF range BUT must be mounted higher than a half wavelength above ground.

Small Loop Basics

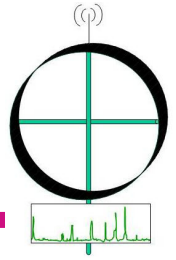

They look electrically like a tuned circuit where the inductor is a large loop with a circumference of about 1/10 wavelength

- 40m ~ 4.5' dia.
- 20m ~ 2.2' dia.
- 10m ~ 1.1' dia.
- But up to 1/4 wave is usable
- Tuned by a capacitor at the loop ends
- Variable cap used for tunability
- Matching means needed for 50 ohm feed

Theory

Small Loop Equivalent Circuit

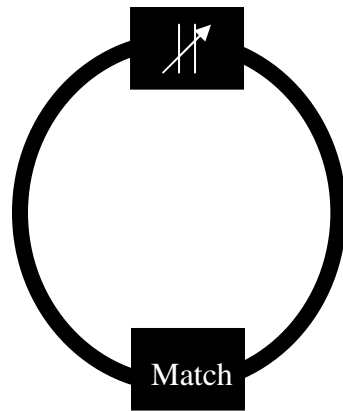
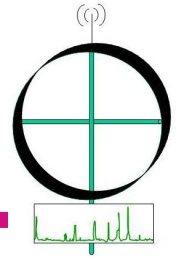

Copper Loop

3 Ft Dia.

1/2 in. tubing

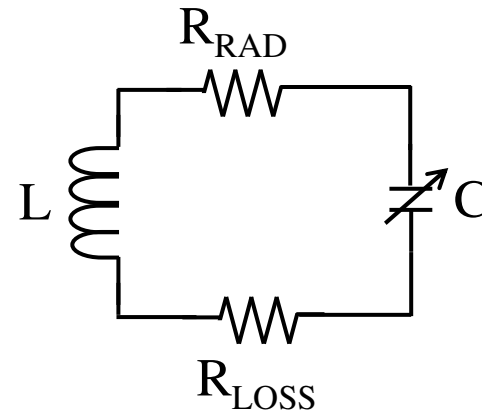

$$L = 2.5 \text{ uH}$$

$$C = 52 \text{ pf}$$

$$R_{\text{RAD}} = .065\Omega$$

$$R_{\text{LOSS}} = .07\Omega$$

$$Q = 810$$

$$BW = 17 \text{ kHz}$$

$$V_{\text{CAP}} = 943\text{v @ } 5\text{W}$$

Theory

Small Loop Design Equations

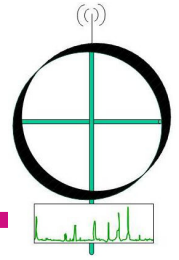

For a circular loop with a tubular copper conductor in free space ...

- **Radiation Resistance - ohms**

$$RR = 3.38 \times 10^{-8} \times (F^2 \times A)^2 \quad \text{!!!!!!!!!!!!!!!}$$

- **Loss Resistance - ohms**

$$RL = 9.96 \times 10^{-4} \times \text{sqrt}(F) \times S / D$$

- **Efficiency - %**

$$\text{Eff} = RR \times 100 / (RR + RL)$$

- **Inductance - uH**

$$L = 1.9 \times 10^{-8} \times S \times (1.2e-.136S + .81) \times (7.353 \times \log_{10} (96 \times S / (\Pi \times D) - 6.3860)$$

- **Q (loaded)**

$$Q_L = 2 \times \Pi \times F / (2 \times (R_R + R_L))$$

- **Bandwidth - kHz**

$$BW = F / Q_L$$

F = Freq (MHz), A = Loop Area (ft) , D = Cond. Dia. (in),



*G. Heron N2APB
& J. Everhart, N2GX*

Theory

aa5tb_loop_v1.22a.xls Calculator

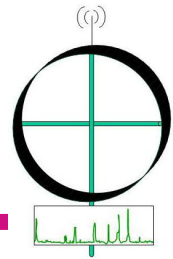

Automates loop design and "what-ifs"

Small Magnetic Loop Antenna Calculator ver. 1.22a

by Steve Yates

AA5TB

aa5tb@yahoo.com

Updated April 28, 2009

Input the following parameters:

Design Frequency =	14.000 MHz
Loop Diameter =	3.000 feet 0.914 m
Conductor Diameter =	0.500 inches 12.700 mm
Added Loss Resistance =	0.000 milliohms
RF Power =	5.000 Watts

Calculated Results:

Bandwidth =	17.266 kHz (-3 dB points)
Efficiency =	48.013 % -3.186 dB
Loop Area =	7.069 ft ² 0.657 m ²
Radiation Resistance =	64.877 mΩ
Total Loss Resistance =	70.246 mΩ
Loop Circumference =	9.425 ft 2.873 m
Wavelength Percentage =	13.415 % λ
Loop Inductance =	2.491 μH
Distributed Capacitance =	7.728 pF
Q (Quality Factor) =	810.851
Tuning Capacitor =	51.879 pF
Capacitor Voltage =	942.556 V
Minimum Plate Spacing =	12.567 mils (1/1000 in) 0.319 mm

Notes:

1. To truly be considered a small loop, the Loop Circumference should be less than 10 % λ. Larger loops will have greater efficiency but smaller nulls.
2. To see the effects of bad joints, etc., input realistic values into the Added Loss Resistance box.
3. The sheets are protected to prevent the user that is unfamiliar with Excel from accidentally corrupting formulas. To unlock the sheets use the password aa5tb.
4. This application is free to use as you wish. If you modify it and pass it on all that I ask is that you give me credit for my part of the work. Thanks!

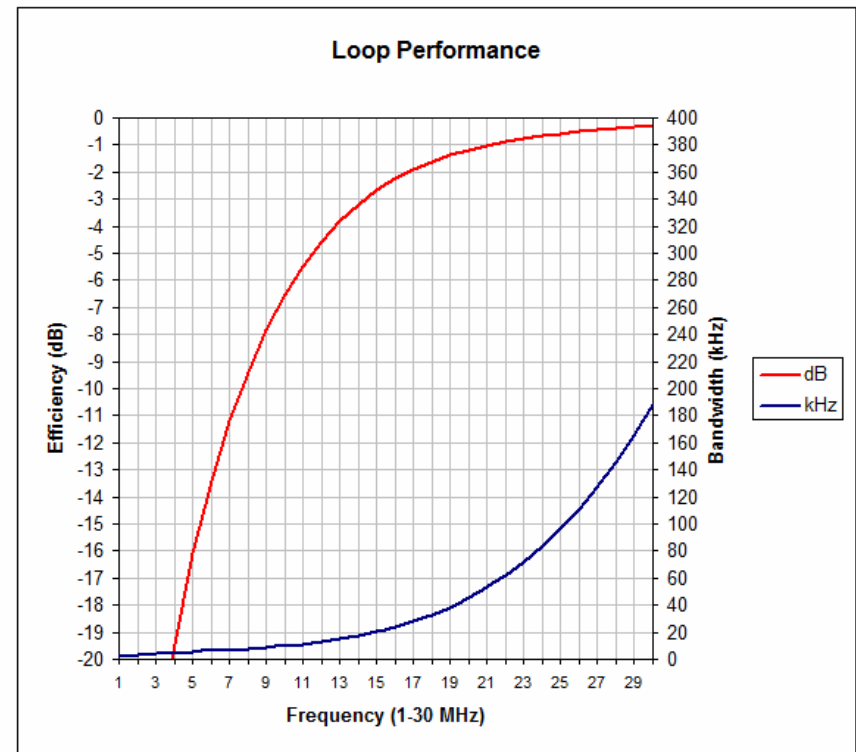

Theory

Minimizing Conductor Loss

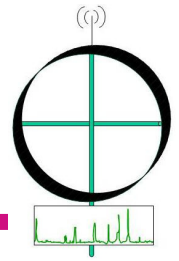

Loss Efficiency and Bandwidth vs Tubing size

Copper						Aluminum					
Dia - in	Rr - mΩ	R _L - mΩ	Eff - %	L - uH	BW - kHz		Rr - mΩ	R _L - mΩ	Eff - %	L - uH	BW - kHz
0.5	64.9	71.2	48	2.5	17.3		64.9	112	36.6	2.5	22.6
1	64.9	35.1	64.9	2.1	15.2		64.9	56.1	53.6	2.1	18.4
2	64.9	17.6	78.7	1.7	15.5		64.9	28.1	69.8	1.7	17.4
3	64.9	11.7	84.7	1.5	16.6		64.9	18.7	81 **	1.5	17.4
4	64.9	8.8	88.1	1.3	18		64.9	14.1	82.2	1.3	19.3

** 3" Al conductor only 1 dB loss
Midnight Loop design goal

Other Loss Factors

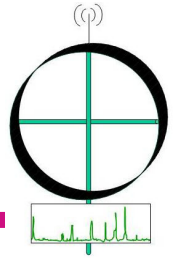

Connections need careful attention

- Any mechanical connection is lossy
- Joints need to be soldered or welded

The tuning capacitor is critical

- Rotary tuning cap needs best insulation
 - Ceramic vs phenolic
- Lowest loss dielectric if used
- Rotary joints generally bad
 - Measured several $m\Omega$ to 20 $m\Omega$
 - Changes each time retuned
- Usual choices are trombone, split stator or vacuum variable

Efficiency Controversy

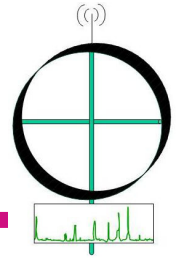

Prof Mike Underhill G3LHZ has challenged established loop design theory claiming very small loop efficiency is actually many dB greater than claimed (Ref 8).

Noted antenna expert **John Belrose VE2CV** has countered with NEC antenna modeling and real-world measurements upholding the established means of deriving small loop efficiency. He concludes that G3LHZ used flawed experimental data and reasoning to uphold his unorthodox views (Ref 9,10).

Theory

Midnight Loop Loss Approach

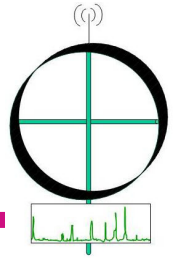

Use a large flat conductor

- Aluminum flashing
- Estimated loss similar to 3" tubing
- Ref 7 gives justification for flat conductor

Ends of loop are overlapped to make capacitor

- Completely jointless construction
- Tuned by varying plate spacing
- Air dielectric for small C
- Low loss Teflon for higher C

Midnight Loop as Equiv to 3 in dia. Tubing

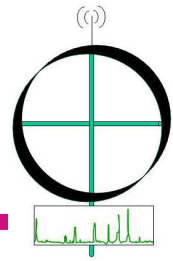

Small Magnetic Loop Antenna Calculator ver. 1.22a

by Steve Yates
AA5TB
aa5tb@yahoo.com
Updated April 28, 2009

Input the following parameters:

Design Frequency =	14.000 MHz
Loop Diameter =	3.000 feet 0.914 m
Conductor Diameter =	3.000 inches 76.200 mm
Added Loss Resistance =	7.000 milliohms
RF Power =	5.000 Watts

Calculated Results:

Bandwidth =	18.142 kHz (-3 dB points)
Efficiency =	77.618 % -1.100 dB
Loop Area =	7.069 ft ² 0.657 m ²
Radiation Resistance =	64.877 mΩ
Total Loss Resistance =	18.708 mΩ
Loop Circumference =	9.425 ft 2.873 m
Wavelength Percentage =	13.415 % λ
Loop Inductance =	1.467 μH
Distributed Capacitance =	7.728 pF
Q (Quality Factor) =	771.682
Tuning Capacitor =	88.124 pF
Capacitor Voltage =	705.509 V
Minimum Plate Spacing =	9.407 mils (1/1000 in) 0.239 mm

Notes:

1. To truly be considered a small loop, the **Loop Circumference** should be less than 10 % λ. Larger loops will have greater efficiency but smaller nulls.
2. To see the effects of bad joints, etc., input realistic values into the **Added Loss Resistance** box.
3. The sheets are protected to prevent the user that is unfamiliar with Excel from accidentally corrupting formulas. To unlock the sheets use the password **aa5tb**.
4. This application is free to use as you wish. If you modify it and pass it on all that I ask is that you give me credit for my part of the work. Thanks!

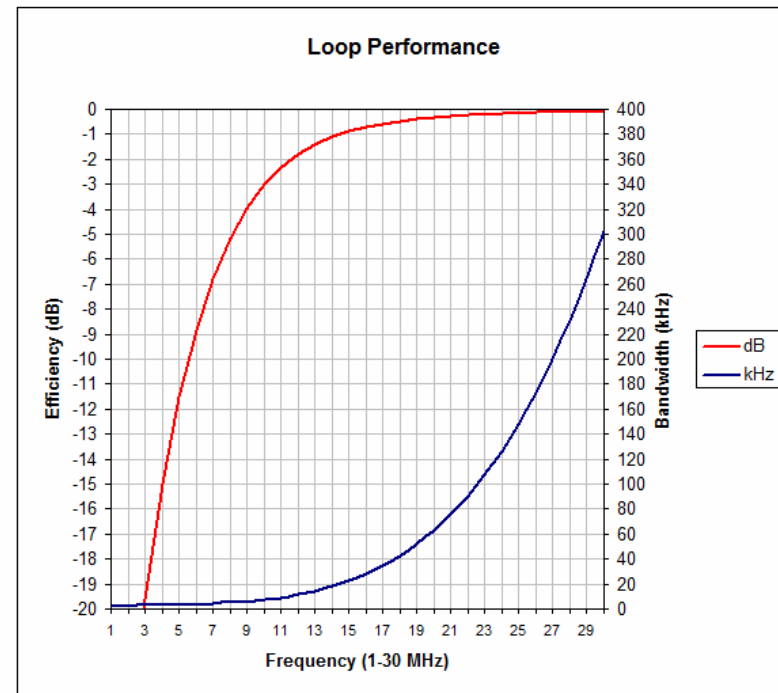

Optimum Tuning Method

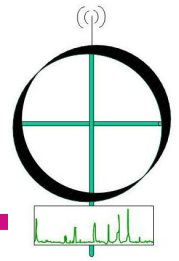

High Q makes tuning difficult

- Manual tuning touchy
- Hand proximity causes detuning

Obvious solution is to motorize

But tuning can still be touchy

- High gear ratio needed
- Tuning to peak noise takes skill
- Watching SWR meter even worse

Midnight loop target approach is a user-friendly visual display

Practice

The Midnight Loop

An Experimental, High-efficiency, Graphic-Tunable Magnetic Loop

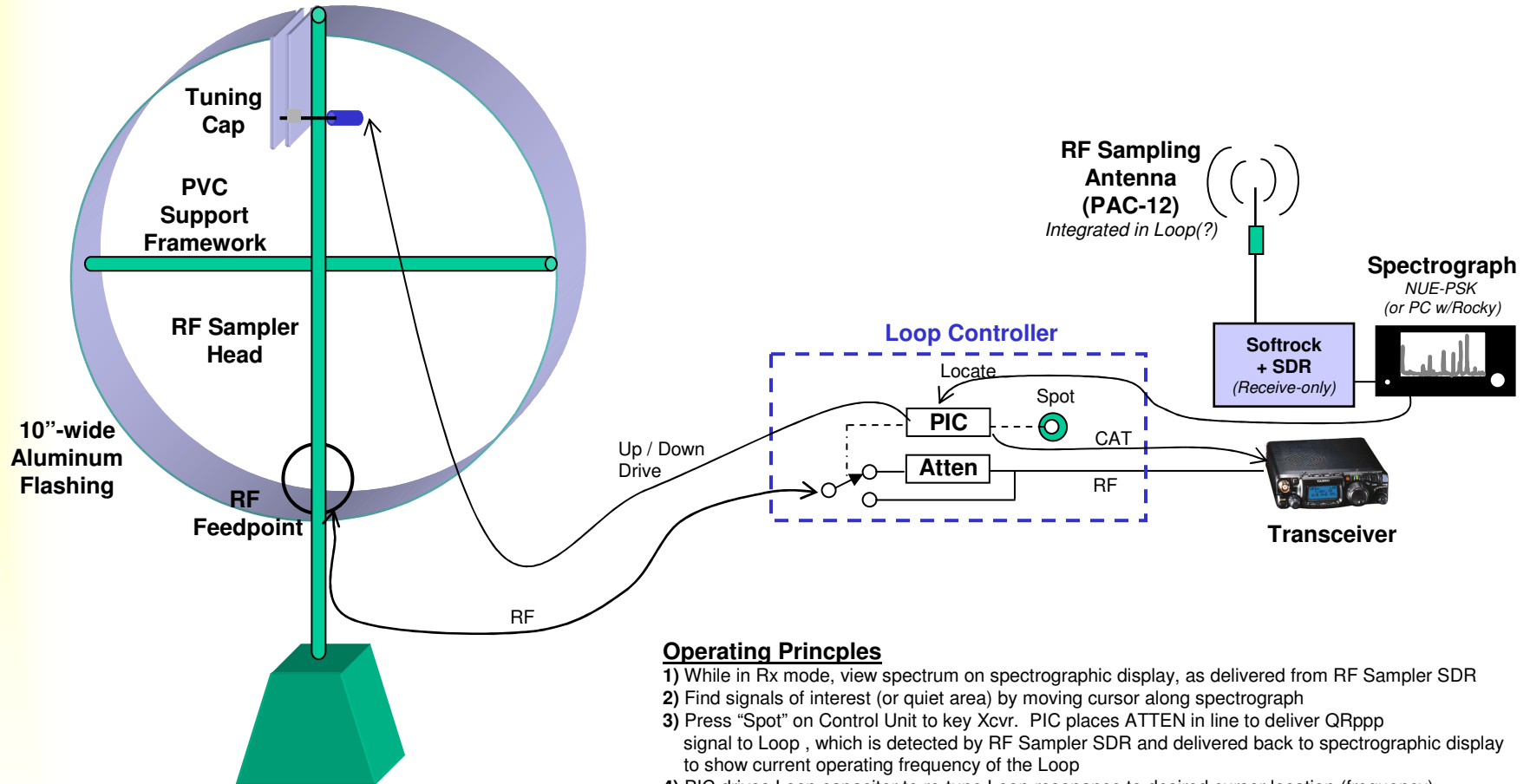
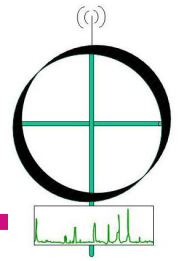

Operating Principles

- 1) While in Rx mode, view spectrum on spectrographic display, as delivered from RF Sampler SDR
- 2) Find signals of interest (or quiet area) by moving cursor along spectrograph
- 3) Press "Spot" on Control Unit to key Xcvr. PIC places ATTN in line to deliver QRppp signal to Loop, which is detected by RF Sampler SDR and delivered back to spectrographic display to show current operating frequency of the Loop
- 4) PIC drives Loop capacitor to re-tune Loop resonance to desired cursor location (frequency).
- 5) PIC switches Attenuator out of circuit, removes power from Sampling SDR, drives Transceiver to the frequency of the cursor in the spectrographic display, and user begins operating per normal.

Practice

Loop Controller

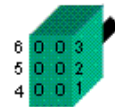
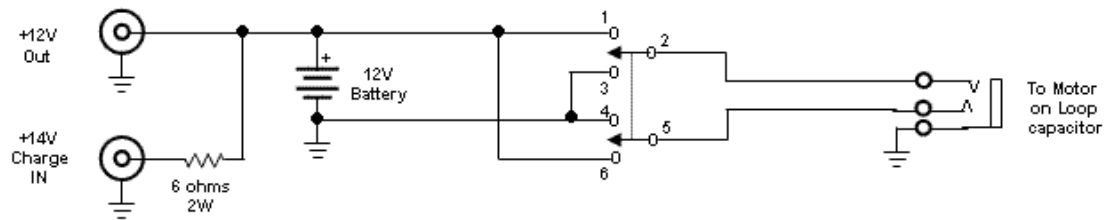
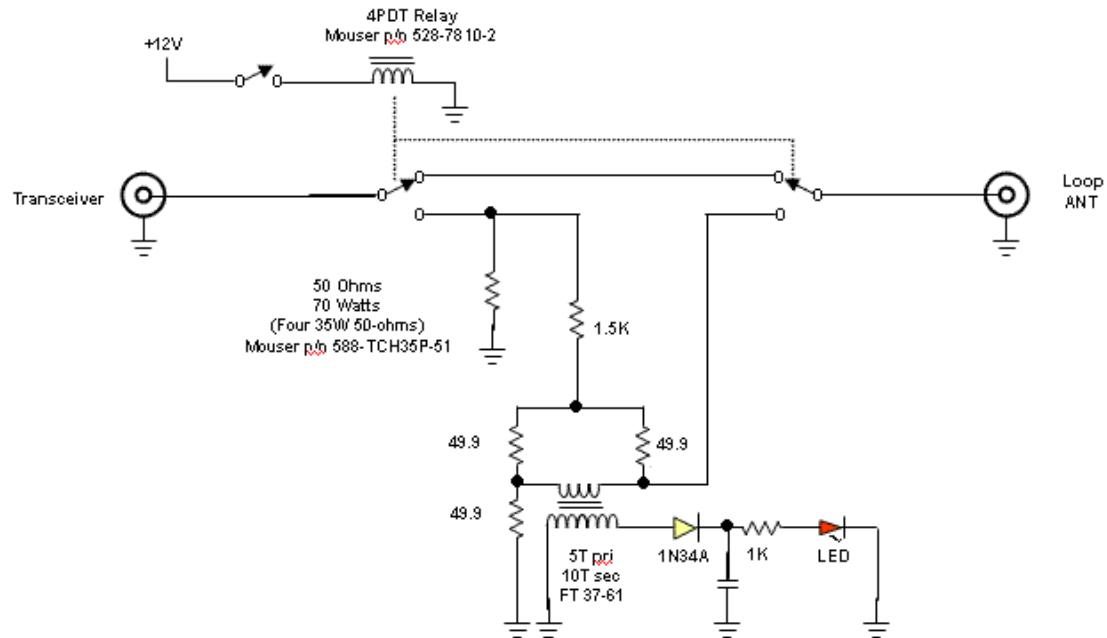
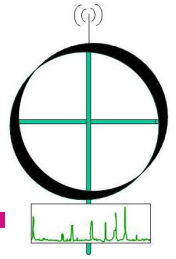

DPDT (Mom-ON-Mom)
Mouser p/n 611-72 15SHCQE

Practice

Loop Controller

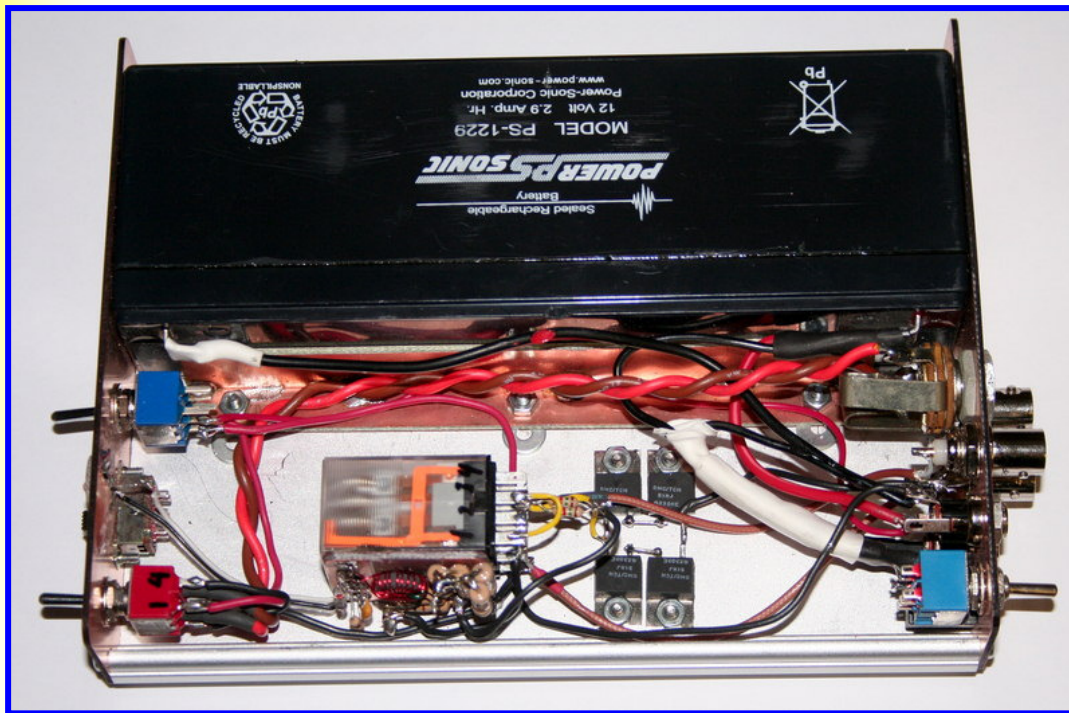
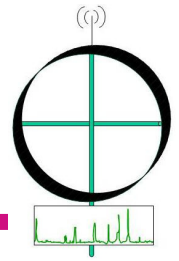

Midnight Loop Controller consists of ...

- 1) Self-contained battery for powering Loop capacitor tuning motor;
- 2) "Up/Down" Switch (red) for manually tuning Loop;
- 3) Relay switching in/out 70W dummy load and N7VE SWR Indication circuit

Practice

SDR Spectrum Tuning Unit

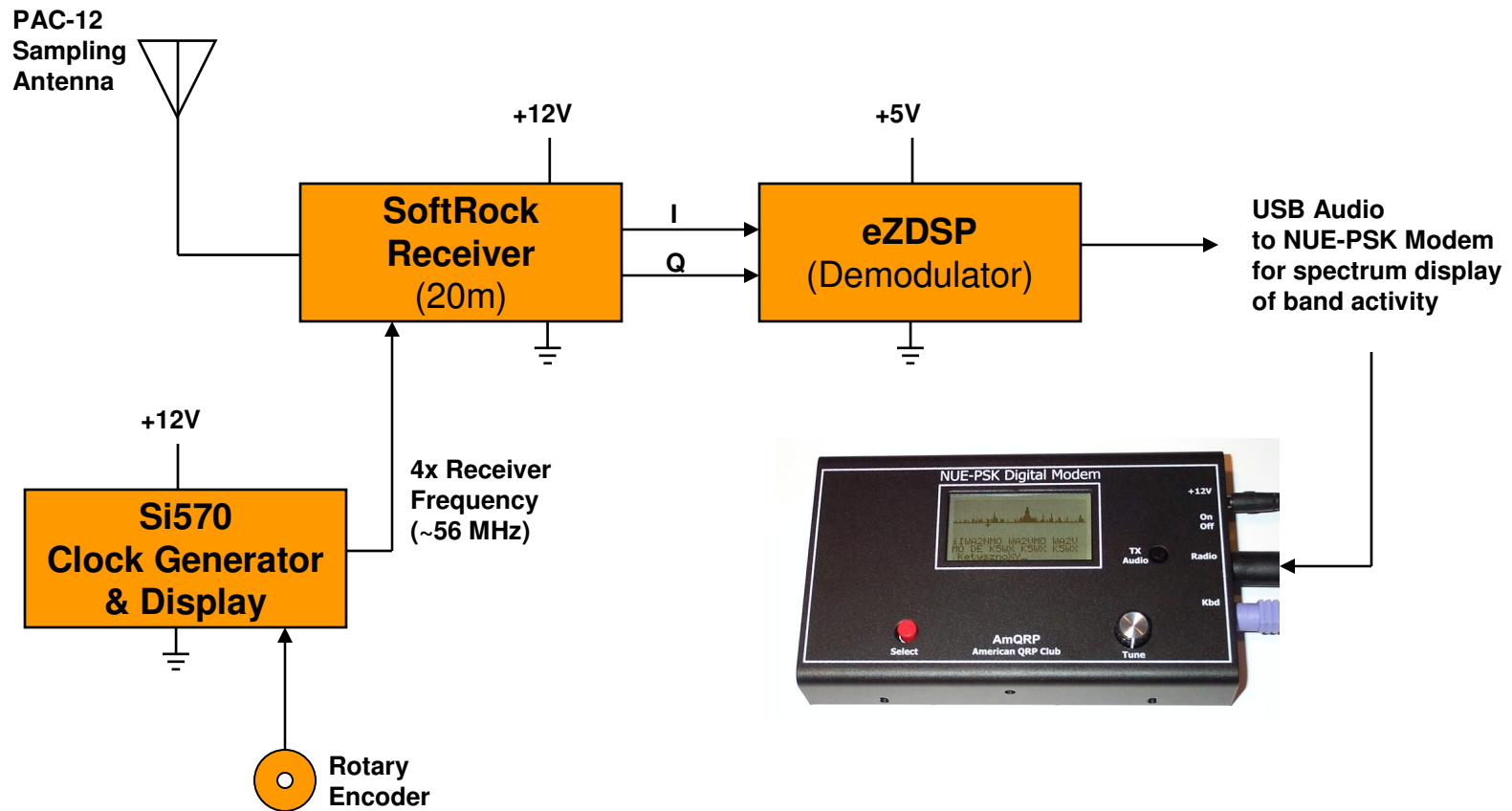
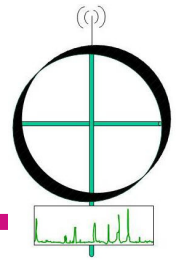

Practice

SDR Spectrum Tuning Unit

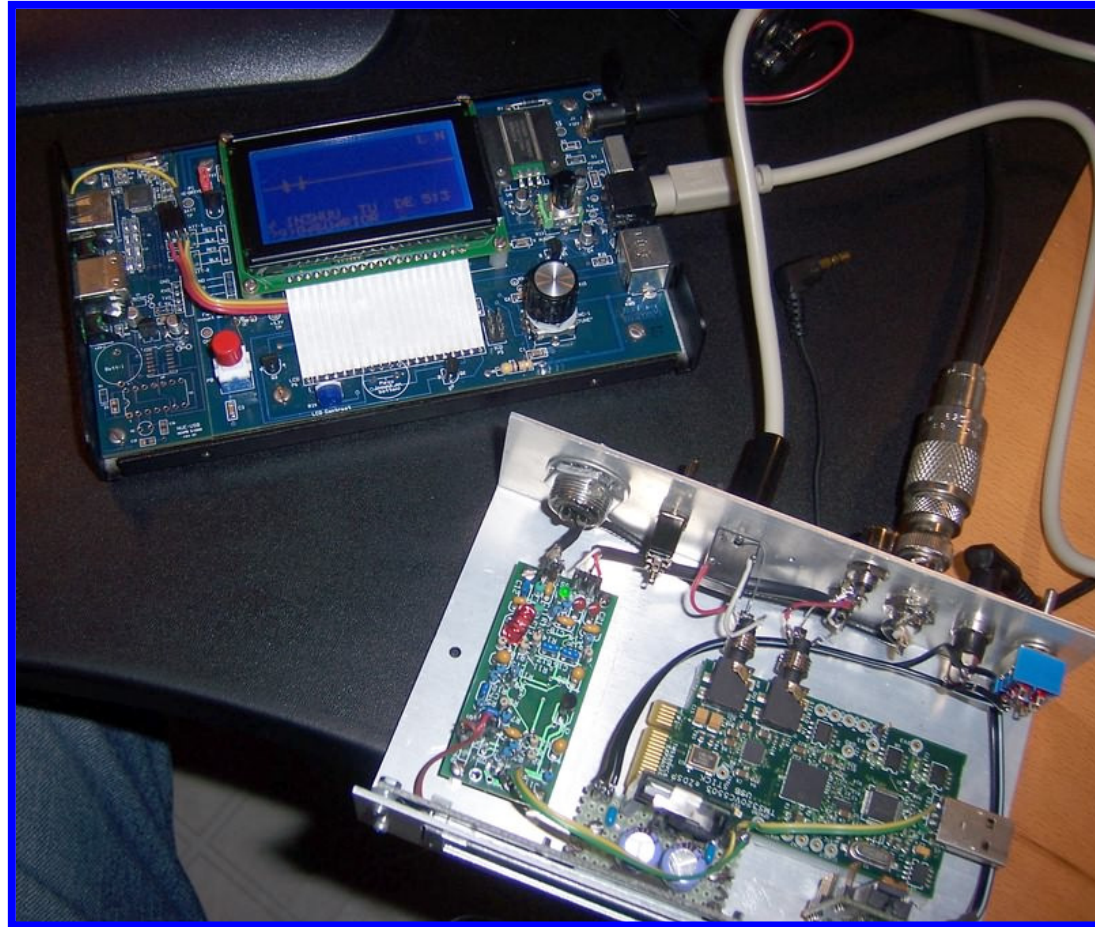
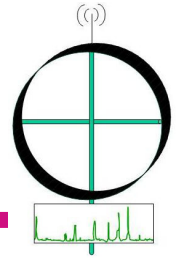

NUE-PSK Digital Modem (upper left)
Spectrum display of SDR output used to display band activity outside the narrow bandwidth offered by the midnight Loop.

SDR Tuning Controller (lower right)
SoftRock v5.0 (left) software defined receiver, eZDSP starter kit running NUE-SDR v0.5 software and Si570 Controller & Frequency Generator on front panel

*G. Heron N2APB
& J. Everhart, N2GX*

Practice

The Station

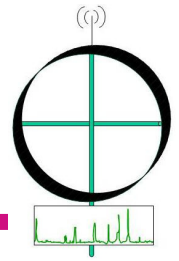

Clockwise ...

**Yaesu's FT-817 QRP transceiver
NUE-PSK Digital Modem (for spectrum display)
Midnight Loop Spectrum Tuning Controller
Midnight Loop Controller**

**Rear view of station
showing cable interconnects**

Practice

In Operation

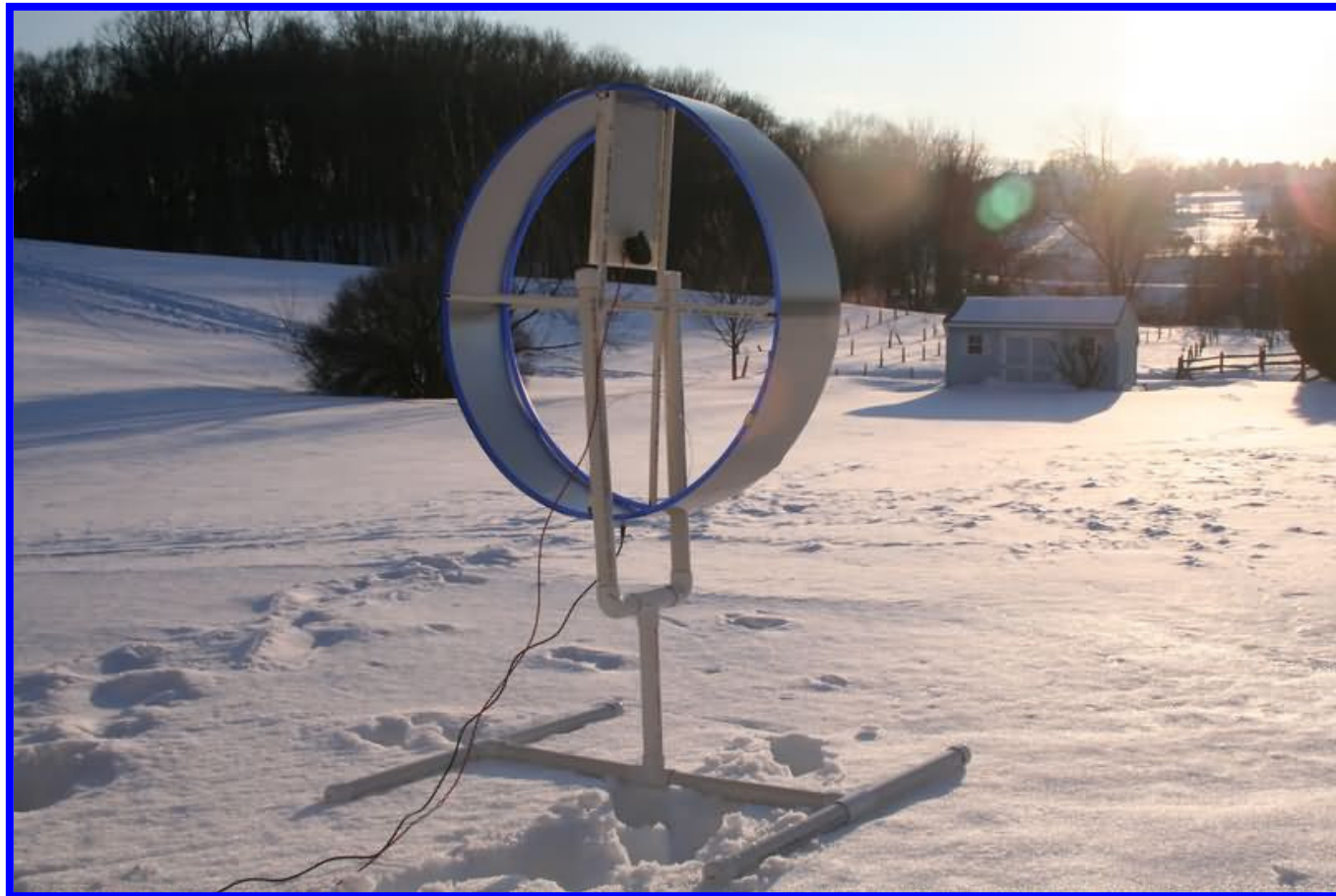
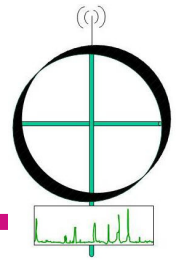

Midnight Loop standing atop three-foot snow in Maryland

Practice

In Operation

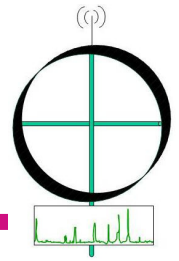

N2APB at the operating position of the Midnight Loop station in snowbound Maryland.

Practice

Comparative Field Testing

Testing under carefully controlled conditions to compare the Midnight Loop to the MFJ Loop

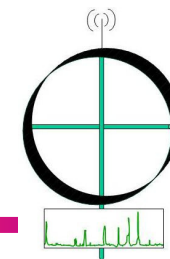

Top View:

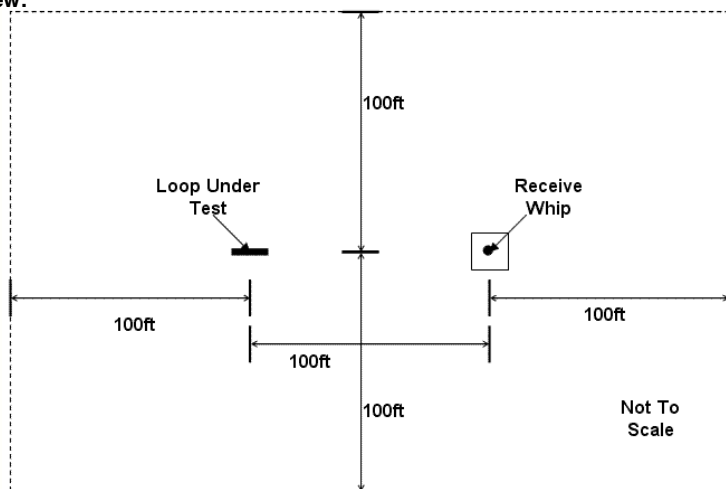

Side View:

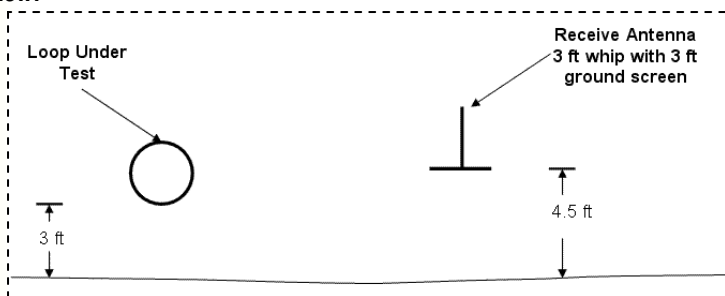

Need flat area free of trees, autos, fences, people, poles, etc. at least 300 feet long and 200 feet wide. Preferably, clear area should be more than twice these dimensions with nothing higher than a couple of feet to avoid unwanted reflections or absorption of RF energy.

In addition there can be no transmitters, large electric motors, power substations, power lines, or other RF interference sources within 1/4 mile.

This testing involves setting up a flat measurement area with no obstructions such as trees, houses, hills, cars, etc to do the test.

The antenna under test is set at a measured distance, say 100 feet from a 3 ft whip over a 3 ft ground plate. It is oriented vertically.

The test antenna has its base at about 3 ft above ground while the 1 meter whip is about 4-1/2 feet above ground.

A transmitter is connected to the antenna under test and its output carefully measured. The 3 foot whip is connected to a test receiver. The latter has to be capable of measuring low signal levels to within 0.5 dB or so repeatably. Either a spectrum analyzer or calibrated test receiver is best. It may be possible to use the Hayward microwattmeter with a sharp bandpass filter.

First the MFJ loop is set up as the test antenna and the transmitter is enabled. The signal at the 3 ft whip is measured as the MFJ loop is rotated. Received signal measurements are made a 90 degree increments. Ideally 0 degrees will be with the loop axis pointed in the direction of the whip.

Next the Midnight Loop is set up as the antenna under test and the above sequence of measurements is repeated.

Finally the MFJ loop is used for a second set up measurements to assure repeatability.

All measurements should be performed within a couple hour period with weather, temperature, etc. remaining relatively constant.

Practice

Comparative Field Testing

The Physical Setup

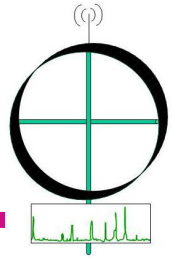

Practice

Comparative Field Testing Results & Observations

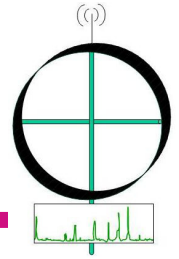

Comparative Loop Antenna Tests						
Forest Hill, MD						Mar 8, 2010
Weather: clear, about 50-degF sunny with a light wind						
Time	Freq (MHz)	SWR	Xmit Pwr (Watts)	Battery (Volts)	Rx Noise (dBm)	Rx Signal (dBm)
Test 1: MFJ Loop oriented toward receive antenna						
2:44 PM	14.080	1.9	0.4	12.4	-67	-24.6
Test 2: MFJ Loop rotated 90 deg. CW						
2:57 PM	14.096	1.9	0.4		-64	-42.1
Test 3: MFJ Loop rotated 180 deg. CW						
3:02 PM	14.096	1.9	0.4		-64	-24.6
Test 4: Midnight Loop oriented toward receive antenna						
3:25 PM	14.02	1.5	.3/.4		-59	-24
Test 5: Midnight Loop rotated 90 deg. CW						
3:38 AM	14.046	1.5	.3/.4	12V	-60	-43
Test 6: Midnight Loop rotated 180 deg. CW						
3:45 PM	14.1	1.8	0.4	11.5V	-68	-23.1

Notes:

1. Approx 40 db S/N ratio at receive end means test data not contaminated by noise
2. 17 dB null with MFJ loop 90 deg. transmission path indicates little or no loop feedline radiation.
3. Identical received signals when MFJ loop turned 180 deg. Shows good pattern symmetry.
4. Stronger received signal from Midnight Loop suggests higher efficiency than the MFJ loop, on the order of 1 dB.
5. Midnight Loop also shows deep null when broadside, suggesting low feedline radiation.
6. Transmit power cannot be accurately accounted for since measurement resolution was 0.1 W. Apparent lower transmit power might yield even higher efficiency for Midnight Loop.

Practice

MFJ Loop Performance

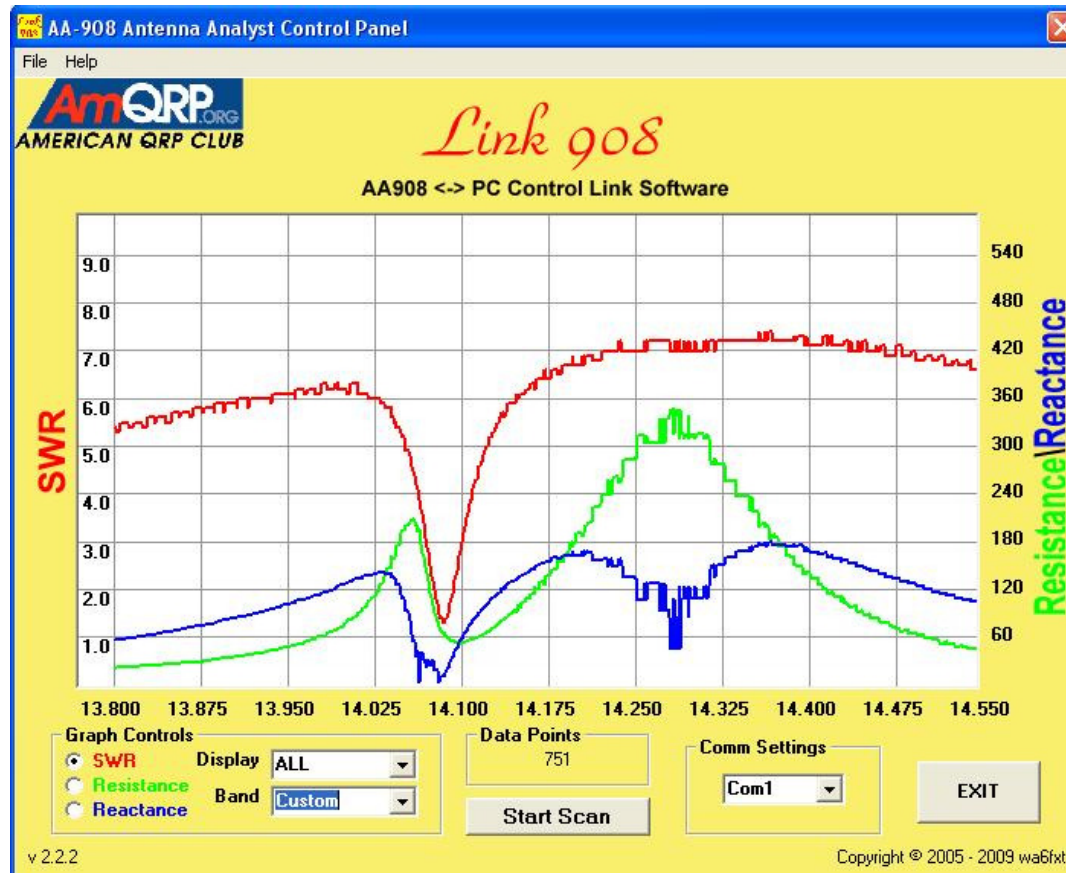
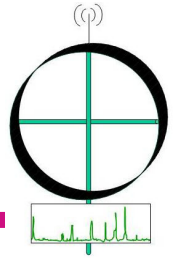

MFJ Loop BW ~ 30 kHz

Practice

Midnight Loop (ground-mounted) Performance

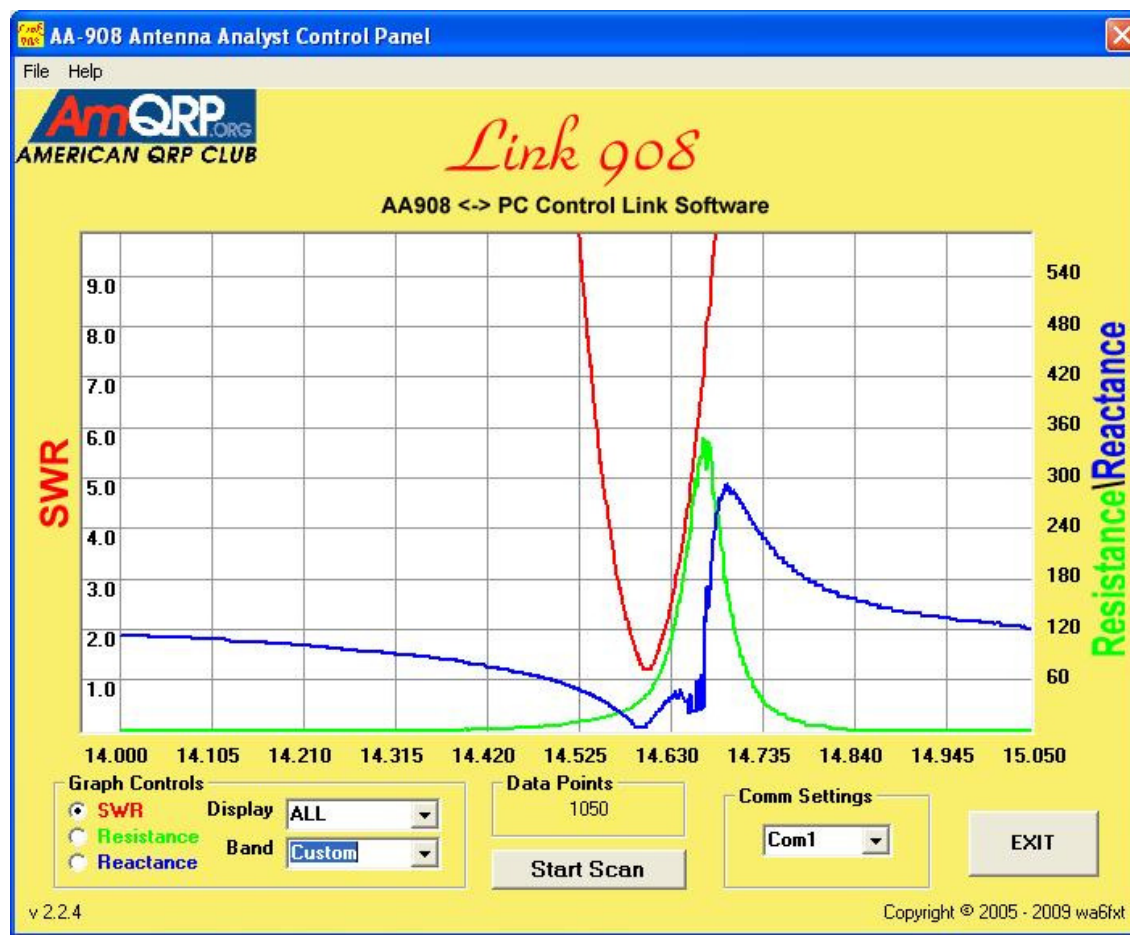
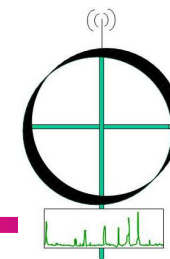

Midnight Loop BW ~ 50 kHz

Practice

Midnight Loop (mounted at 30 feet) Performance

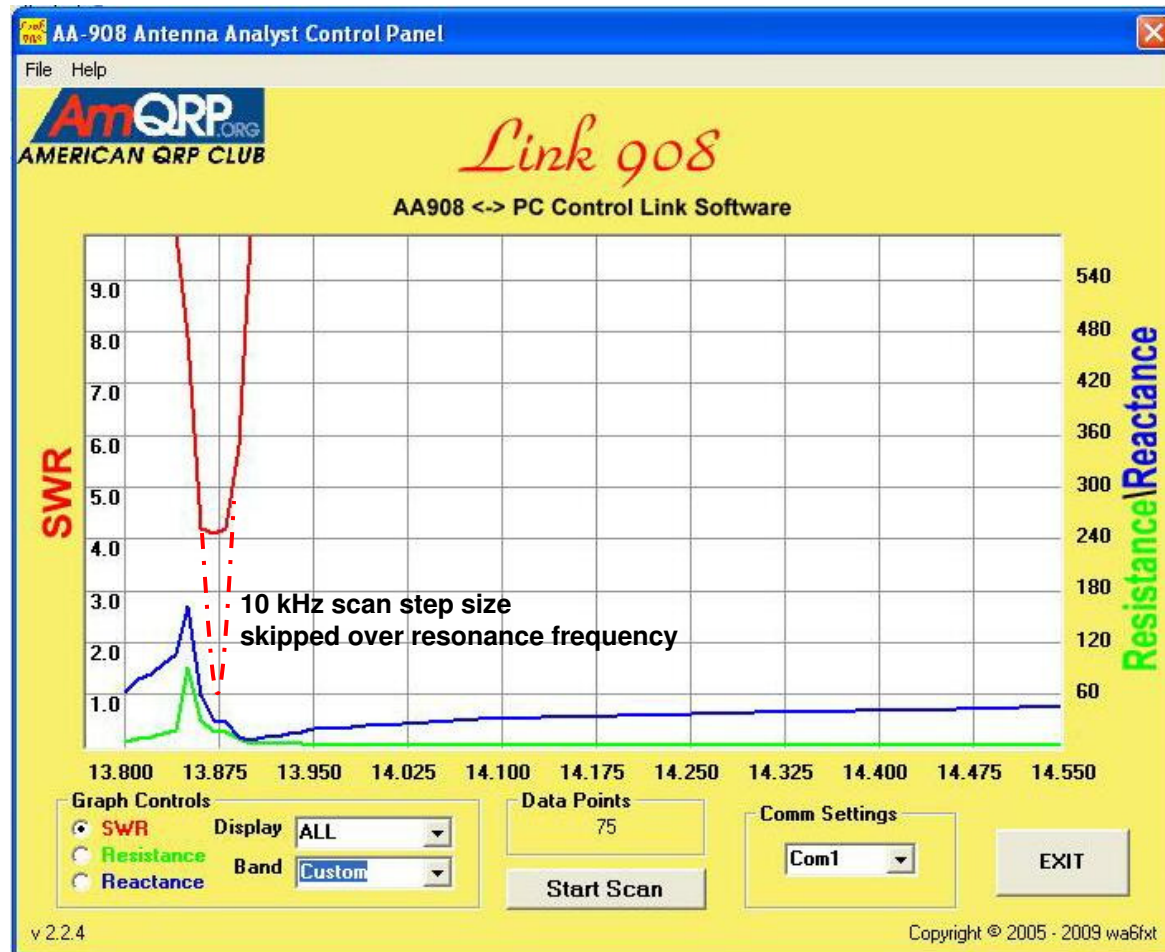
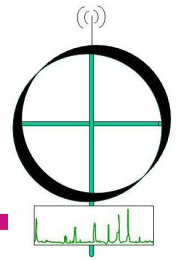

Midnight Loop BW ~ 20 kHz

Practice

Midnight Loop (mounted at 30 feet) Performance

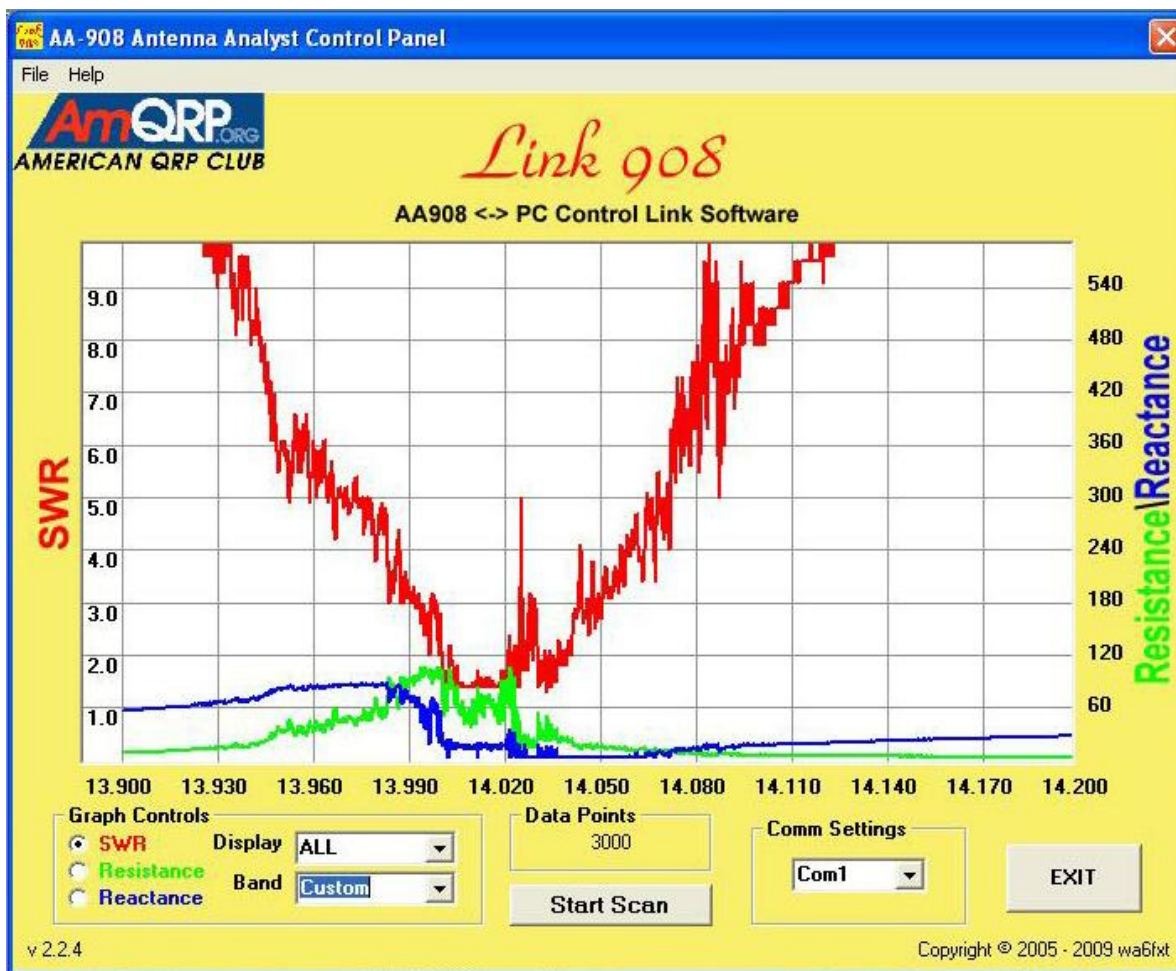
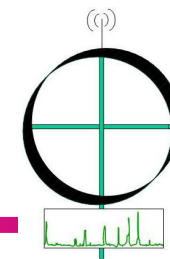

Midnight Loop BW ~ 40 kHz

Practice

Midnight Loop (mounted at 30 feet) Performance

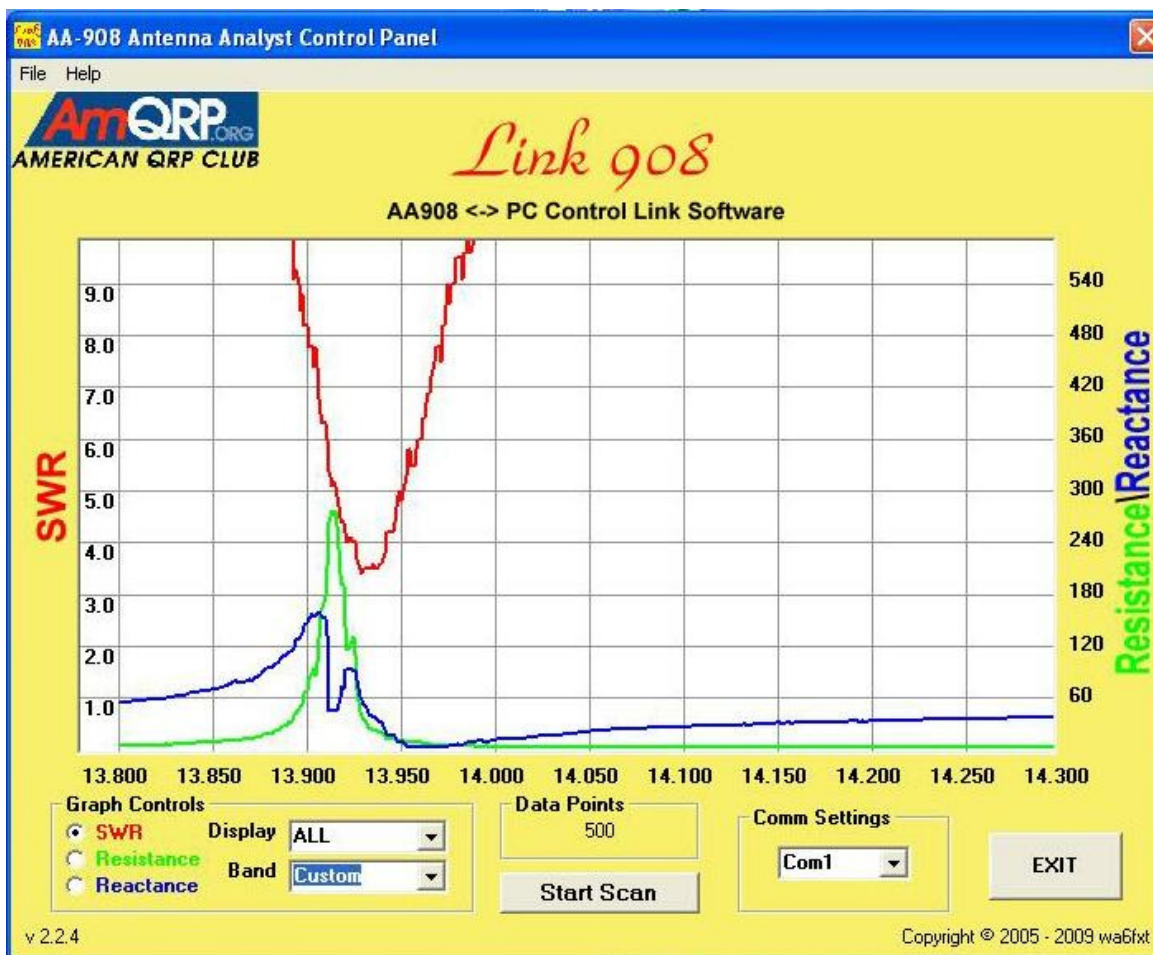
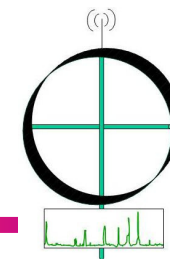

Midnight Loop BW ~ 20 kHz

Practice

Midnight Loop (mounted at 30 feet) Performance

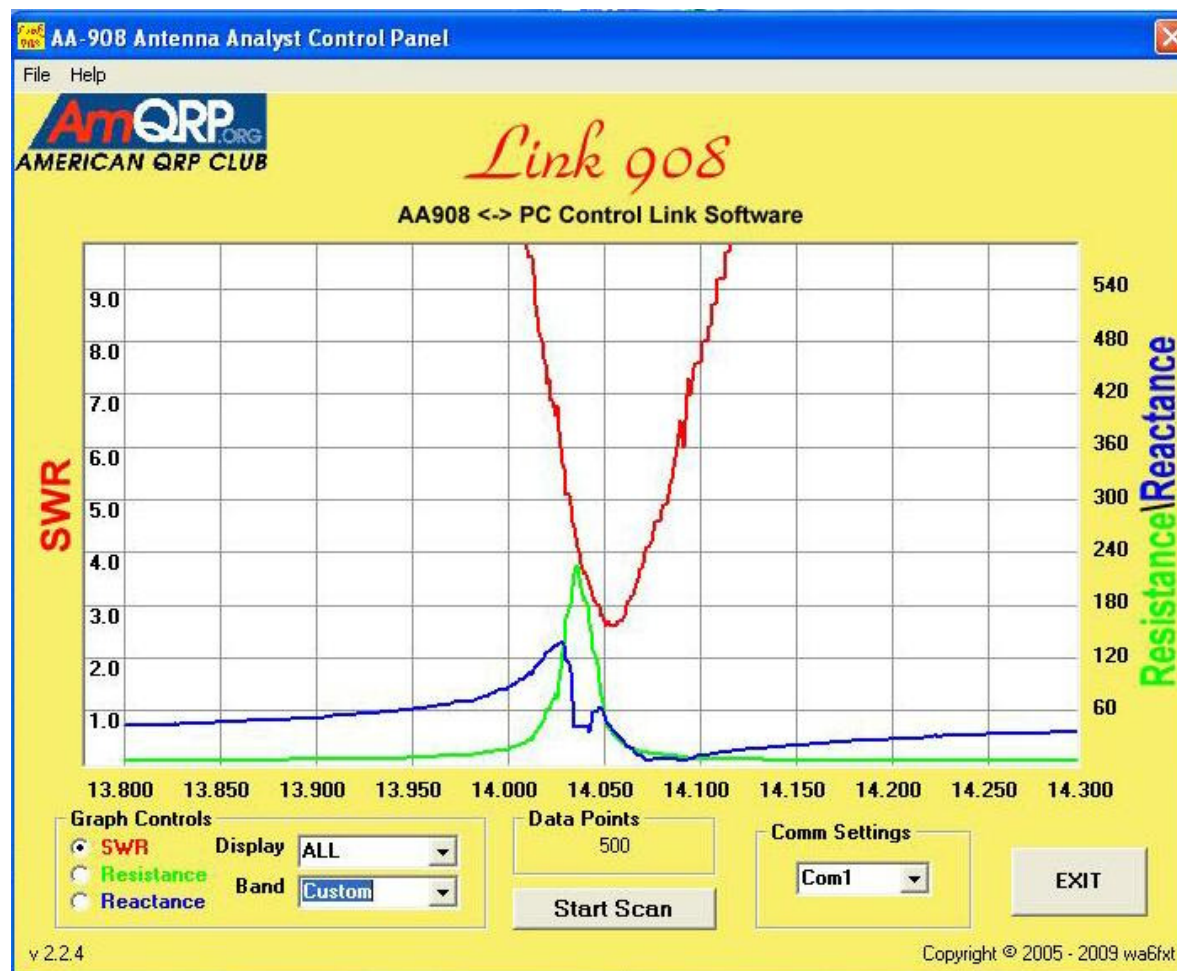
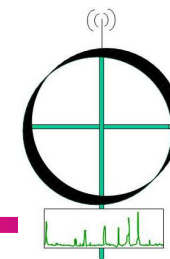

Midnight Loop BW ~ 30 kHz

Demo

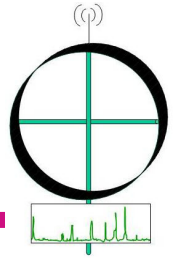

Live Demo

and/or

Video

Next Steps

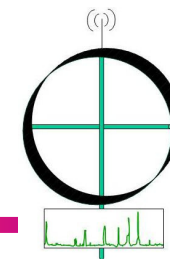

- More field measurements
- Empirically determine RLOSS
- Try copper instead of aluminum
- Integrate sampling antenna
- Integrate controller

Q&A

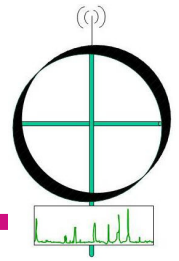

Thank you!

Updated slides available online at ... www.midnightdesignsolutions.com/MidnightLoop



George Heron, N2APB
n2apb@verizon.net

George's interests include homebrewing, QRP CW operation on HF, advanced technology merging computer and radio technologies (DSP, microcontrollers, software development for ham radio applications), and field/portable operation and its related equipment. He was previously the chief scientist at McAfee and currently runs a cyber security consultancy in Baltimore, MD. George has been a longtime member of the NJ QRP club, the editor of the American QRP Club *Homebrewer* magazine, and has helped organize many successful Atlanticon conferences. George was inducted into the QRP Hall of Fame in 2001.

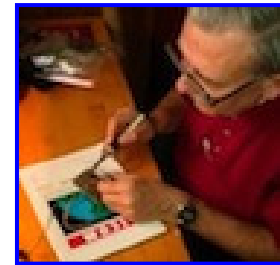

Joe Everhart, N2CX
n2cx@verizon.net

Joe has worked over 30+ years in the aerospace industry on projects ranging from LF antennas through the S-band comm system on the ISS Alpha. Throughout this time he has been an avid homebrewer and always ready to share what he's learned. Joe is an active member of several ham and QRP organizations and is involved the development of kits offered by several clubs including the NJQRP and AmQRP. Joe has written extensively in several QRP publications and was one of the prime movers for the Atlanticon conferences. Joe was inducted into the QRP Hall of Fame in 2000

Appendix

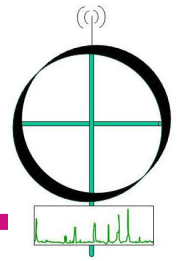

- Background Literature
- References
- Construction Details

References (1 of 5)

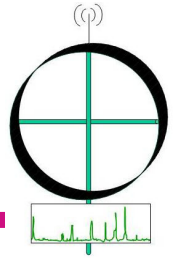

Loop Analysis Calculators

1) *aa5tb_loop_v1.22a.xls calculator*

Good overall calculator. Does not account for ground loss, handles only round loops – works with OpenOffice as well as MS Excel. http://www.aa5tb.com/aa5tb_loop_v1.22a.xls

2) *KI6GD calculator*

More general than the AA5TB calculator. <http://www.magneticloopantenna.com/loopcalc.zip>

3) *G4FGQ Calculators*

Numerous DOS calculator programs including several for small loops. Handles many more parameters than above calculators, though we have not verified accuracy. <http://www.zerobeat.net/G4FGQ/page3.html>

References (2 of 5)

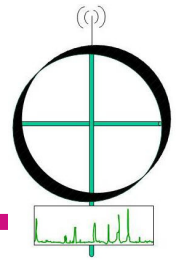

Selected Small Transmitting Loops in radio amateur publications:

1) *The Army Loop in Ham Communication*, L. McCoy W1ICP, QST Mar 1968 pp 17-18, 150

Loop antennas designed for NVIS (Near Vertical Incidence Signaling) built by the US Army for use in Vietnam. NVIS characteristic provided needed close-in communications at the low end of the HF band and avoided high signal loss from jungle foliage. ARRL staffer duplication resulted in an admittedly lossy antenna that was still quite usable.

2) *Small High-Efficiency Loop Antennas*, Ted Hart W5QJR, QST Jan 1986

Hart documented the design of magnetic loops with a set of succinct equations in this piece. It showed how successful loops could be built with predictable, repeatable performance. Material from this article also appears in recent *ARRL Radio Amateur Handbooks* and *ARRL Antenna Books*.

3) *Loop Book*, Ted Hart W5QJR Antennex – www.antennex.com Available by purchase only

An expanded treatment of small loop and related antennas well worth purchasing by serious loop experimenters.

4) *Transmitting Short Loop Antennas for the HF Bands*, Roberto Craighero I1ARZ, *Communications Quarterly* 1993 Summer/Autumn

A thorough description of how to make a very efficient, remotely tunable small transmitting loop.

5) *An Update on Compact Transmitting Loops*, J. S. Belrose VE2CV, QST Nov 1993, pp 37-40

Good treatment of loop antennas and their characteristics with NEC modeling data and measurements to evaluate performance. Belrose is an eminently qualified yet practical antenna expert who has written many classic antenna articles in radio amateur literature.

6) *Performance of Electrically Small Transmitting Loop Antennas*, J. S. Belrose VE2CV, Part I, *RadCom*, pp. 64-67, Part II, *RadCom*, pp. 88-98, June/July 2004

Updated and expanded small transmitting loop data with additional NEC modeling and supporting antenna range measurement data.

7) *Resistance of Foil Conductors For Antennas*, Rudy Severns N6LF, QEX May/June 2002 Tech Notes

Justification for the use of wide, thin foils as low loss conductors for antennas. Results of computer modeling show that “current crowding” at the edge of wide conductors offers significantly less loss than has been popularly thought.

References (3 of 5)

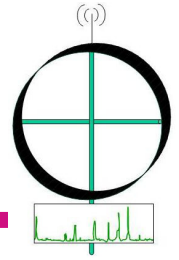

Small Loop Antenna Controversy

8) *The Truth about Loops*, Mike Underhill, G3LHZ, RSGB International Antenna Collection, 2003

In this paper and several others Mike Underhill and Electrical Engineering professor claimed that current theory and descriptions of the efficiency and radiating effectiveness is flawed. He claims that criteria used to evaluate this type of antenna is incorrect and can lead to discrepancies in efficiency of up to 30 dB.

9) *Truth and Untruth*, J. S. Belrose VE2CV, Presented at the QCWA 2004 International Convention, Amateur Radio Technical Session, Friday, October 15, held at the Lord Elgin Hotel, Ottawa, ON Canada – available at <http://qcwa70.org/truth> and [untruth.pdf](http://qcwa70.org/untruth.pdf)

10) *Compact Loops Re-visited*, J. S. Belrose VE2CV, *Antennex Online Magazine*, Mar 2001 issue (13-page article) available by paid subscription only

Noted expert Jack Belrose refutes the claims of Mike Underhill about performance of small loop antennas and presents credible modeling and test data to uphold the traditional methods for efficiency and effectiveness calculations in Refs 9 and 10.

References (4 of 5)

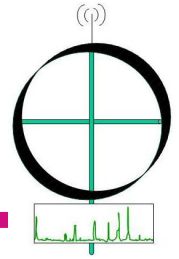

Control, Software and Electronics

1) *An SWR Null Meter, Paul Christensen, W9AC, QST February 2010, pp 30-32.*

Describes a convenient technique for on-the-air tuning that provides only very low transmitted power levels. This approach was utilized in the Midnight Loop Controller.

2) *N7VE LED SWR Indicator*

Dan Tayloe, N7VE designed a simple and convenient absorptive SWR indicating circuit some years ago, used in the NorCal BLT tuner kit (http://www.norcalqrp.org/norcal_blt.htm), and other places. We used this circuit in the Midnight Loop Controller.

3) *SoftRock SDR, Tony Parks KB9YIG*

As a basis for the Midnight Loop's "software defined radio sampling head", we used the popular and inexpensive SoftRock SDR circuits designed and produced by Tony Parks, KB9YIG. See his website (<http://www.kb9yig.com/>) to view his complete line of SoftRock receivers, transmitters, transceivers and accessories.

4) *NUE-SDR Software version 0.5, M.Cram W8NUE*

The genesis of the standalone DSP software called "NUE-SDR", developed by Milt Cram, W8NUE, written for the Texas Instruments "eZDSP Stick" platform (<http://focus.ti.com/docs/toolsw/folders/print/tmdsezd2812.html>)

5) *NUE-PSK Digital Modem, M.Cram W8NUE and G.Heron N2APB*

The spectrum display of the NUE-PSK modem was effectively used in the Midnight Loop tuning system to display band activity outside the view of the narrow-BW loop. (<http://www.nue-psk.com/>)

6) *Si570 Controller & Frequency Generator, Kees Talen K5BCQ and John Fisher K5JHF*

We used this wonderful and inexpensive frequency generator and display in the Loop's Spectrum Tuning Controller SDR. It is produced by K5BCQ and K5JHF of the Austin QRP Club (<http://www.qsl.net/k5bcq/kits/kits.html>)

References (5 of 5)

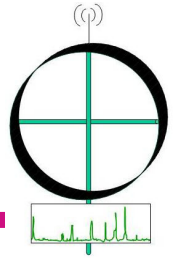

Web References

1) *Steve Yates AA5TB site* <http://www.aa5tb.com/loop.html>

One of the best overall reference sites on the Web describing the theory and practice of small transmitting loop antennas. Has additional links to other sites.

2) *KI6GD site* <http://www.magneticloopantenna.com/>

Yet another good site for the serious loop fan. Also has other links.

3) *W2BRI site* <http://www.standpipe.com/w2bri/>

Excellent site for low HF band very efficient transmitting loops, including a 12' x 12' square loop for 80 meters

4) *MFJ site* www.mjfenterprises.com

MFJ sells some pretty good HF loops, pricey, but good

5) *PY1AHD site* <http://www.alexloop.com/>

Alex Grimberg sells several varieties of small transmitting loops that can be quite handy for portable or hand-portable use. He describes a number of different configurations he has designed and some videos of the loops in use on the air.

6) *G4TPH site* <http://www.g4tph.com/>

Tom Brockman sells several unique small transmitting loops which break down into small sections for easy transport and setup for temporary installations.

Milli-Ohmmeter

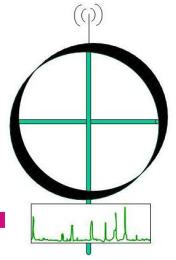

Minimizing loss resistance in small transmitting loops is important. A simple constant current source is useful in measuring DC loss resistance in loop joints and connections in tuning capacitors.

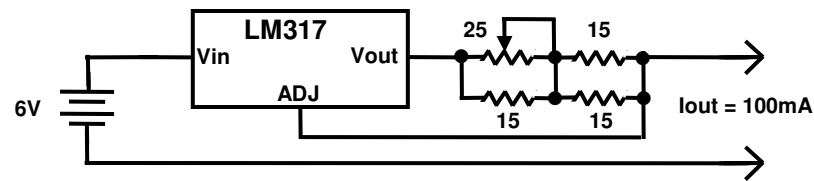

N2CX – 100 mA Constant Current Source

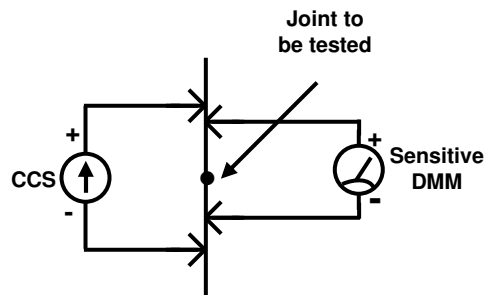

Milliohm Measurements

Adjust pot for 100 ma into short circuit

Connect CCS to resistance under test – up to 10 ohms

Measure drop across resistance

Scale factor 0.1 mV = 1 milliohm

Measuring STL Resonant Frequency

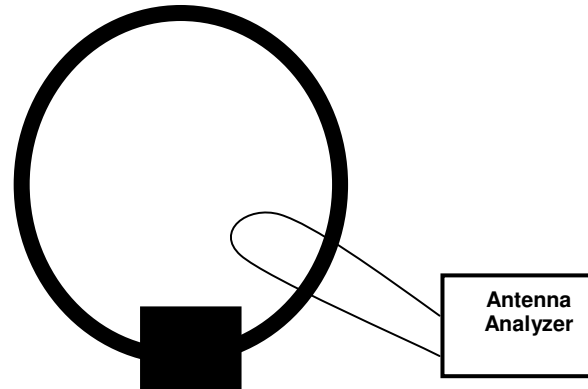
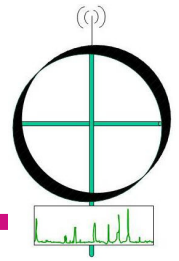

Figure 1 – Ant Analyzer “dipper” setup

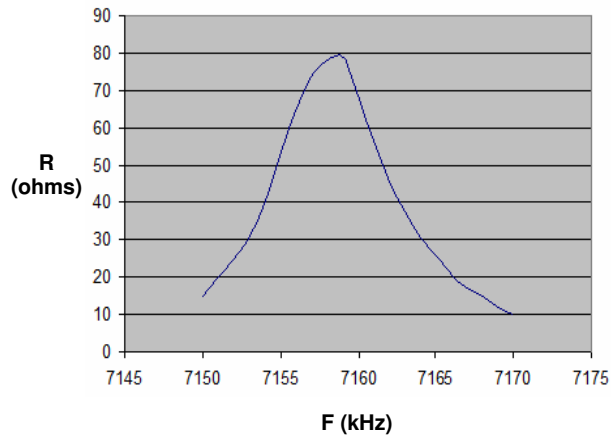
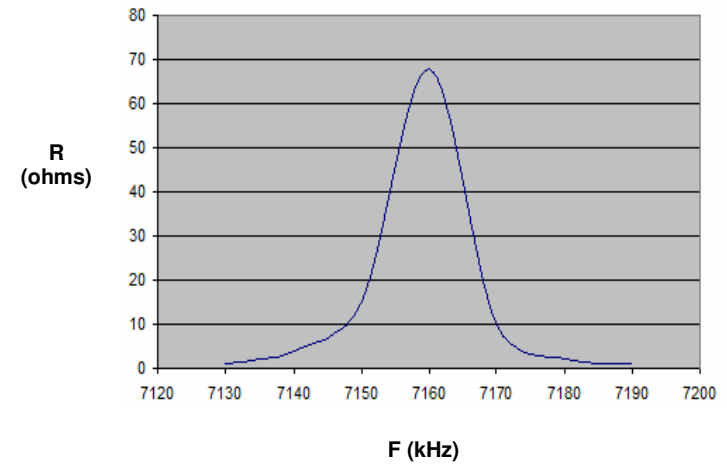
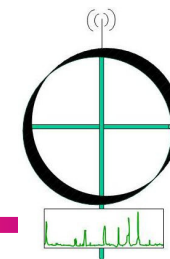

Figure 3 – R vs F (close in)



MFJ Super High-Q Loop Calculations



MFJ-1788



www.mfjenterprises.com

- Loop is 3 ft dia made of 1.1" dia aluminum tubing
- Remotely tuned via control signals over coax feedline
- Built for permanent indoor/outdoor installation
- Best of small transmitting loops for amateur use in U.S
- 40m efficiency comparable to mobile whip
- Better efficiency on 20 and 30 m.

Band	Calculated			
	R _R - mΩ	R _L - mΩ	BW - kHz	Eff - %
40m	4.1	36	6	10
30m	17.5	43.4	9.5	29
20m	64.9	51	18	56

PY1AHD AlexLoop Calculations

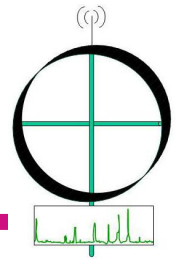

- Loop is 95 cm dia made of 3.8" dia copper tubing
- Manually tuned
- Intended for hand-held portable use.
- Efficiency on 20 m and above similar to or better than mobile whip
- Apartment-bound PY1AHD has made 100's of SSB QSO's operating using hand-held loop with FT-817

<http://www.alexloop.com/>

Band	Calculated			
	R _R - mΩ	R _L - mΩ	BW - kHz	Eff - %
40m	5	69	8.4	6.4
30m	21	83	11.8	20
20m	76	97	19.8	44
15m	384	119	58	76
10m	1214	138	155	90

G4TPH ML-40 Loop Calculations

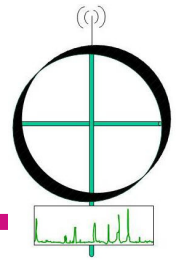

- Loop composed of aluminum strips 1/16" x 3/8" bolted together.
- Approximates a circle 5.05' dia
- Manually tuned
- Calculations performed using a 0.24" tube
- Assumed 10 milliohms joint loss and 10 m-ohms cap loss – minimal compared to conductor loss.
- Calculations show somewhat less than the optimistic manufacturer's estimate however they are in the ballpark of most mobile antennas and the loop is much more convenient for portable operation.

<http://www.g4tph.com/>

Band	Calculated				Mfr Est.
	R _R - mΩ	R _L - mΩ	BW - kHz	Eff - %	
40m	33	299	19.5	9.8	24
30m	141	355	29.2	28.5	68
20m	521	414	55.1	55.7	79

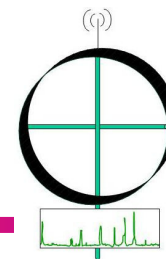

Loop Construction

END VIEW

Sheet Metal Screws
Hold flashing to tube

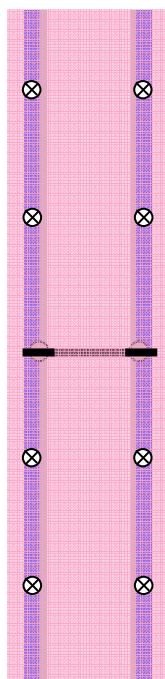

PERSPECTIVE VIEW

(Flashing not shown)

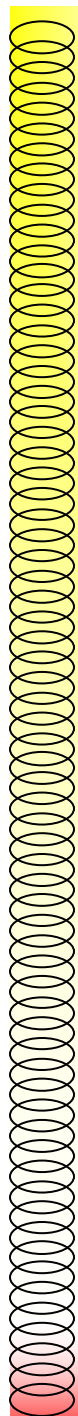
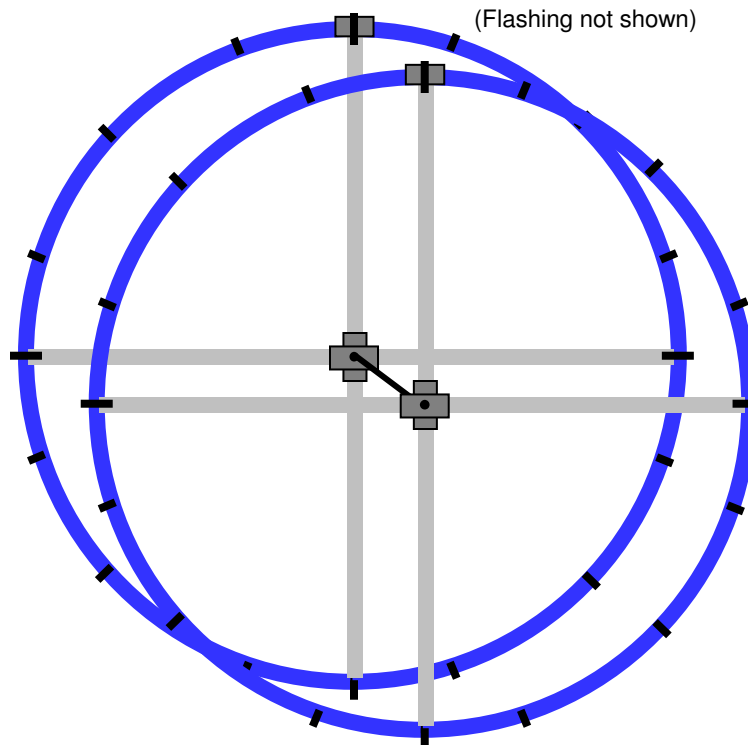

Loop Construction

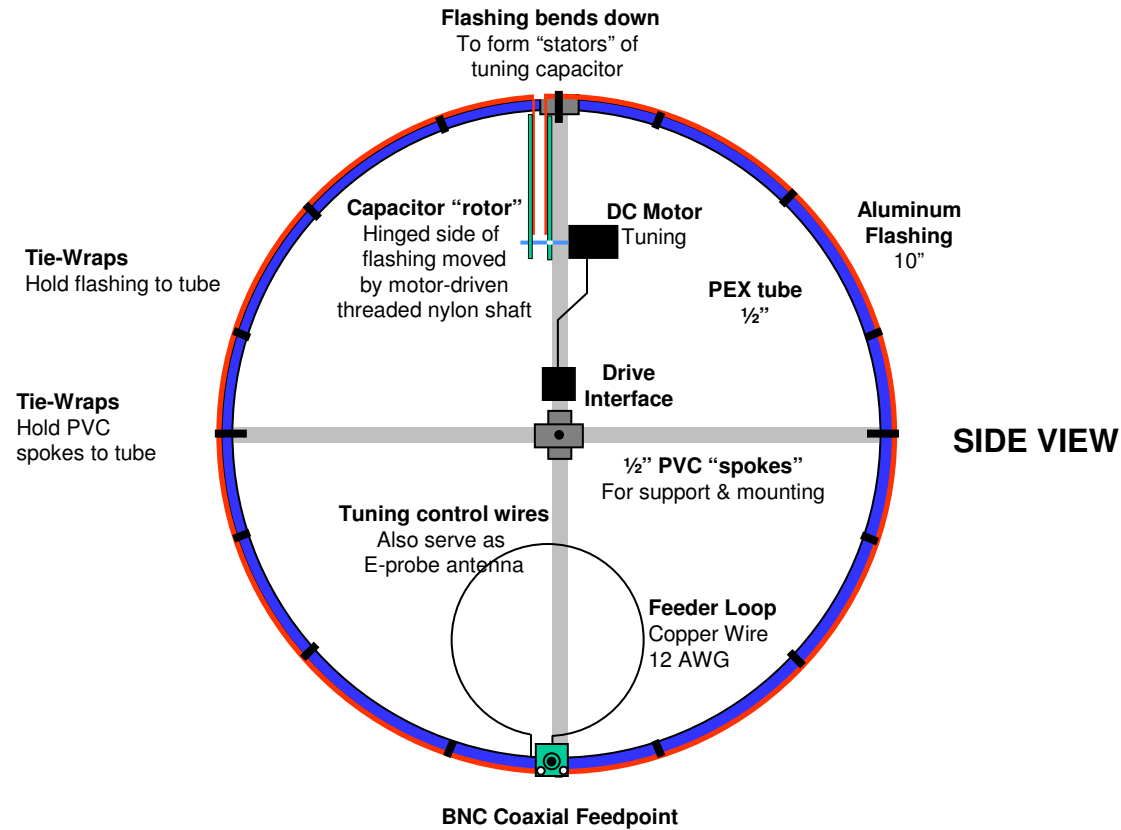
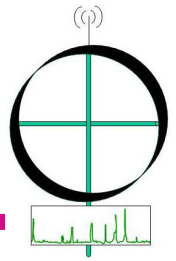

Loop Construction

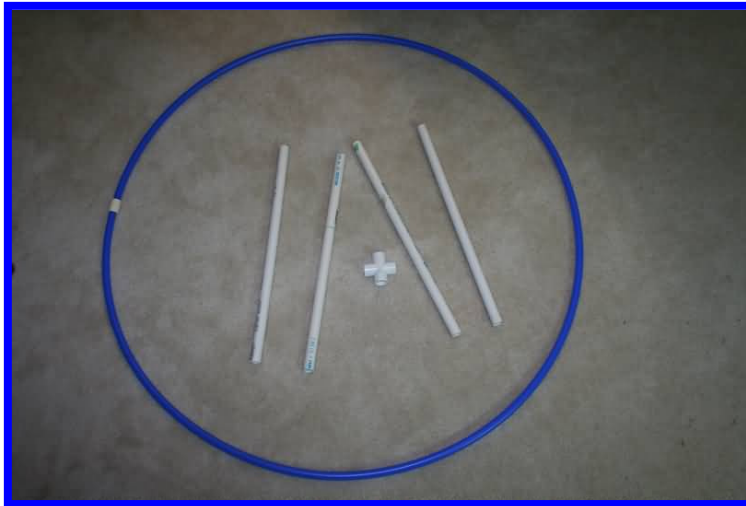
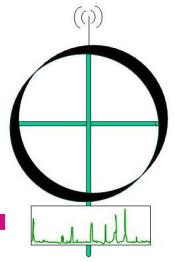

Practice

Comparative Field Testing

The Physical Setup

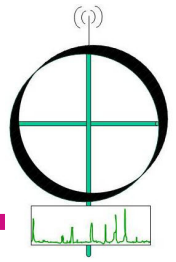

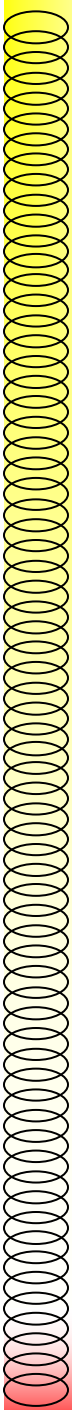

The Midnight Loop

MassCon 2010

*G. Heron N2APB
& J. Everhart, N2GX*

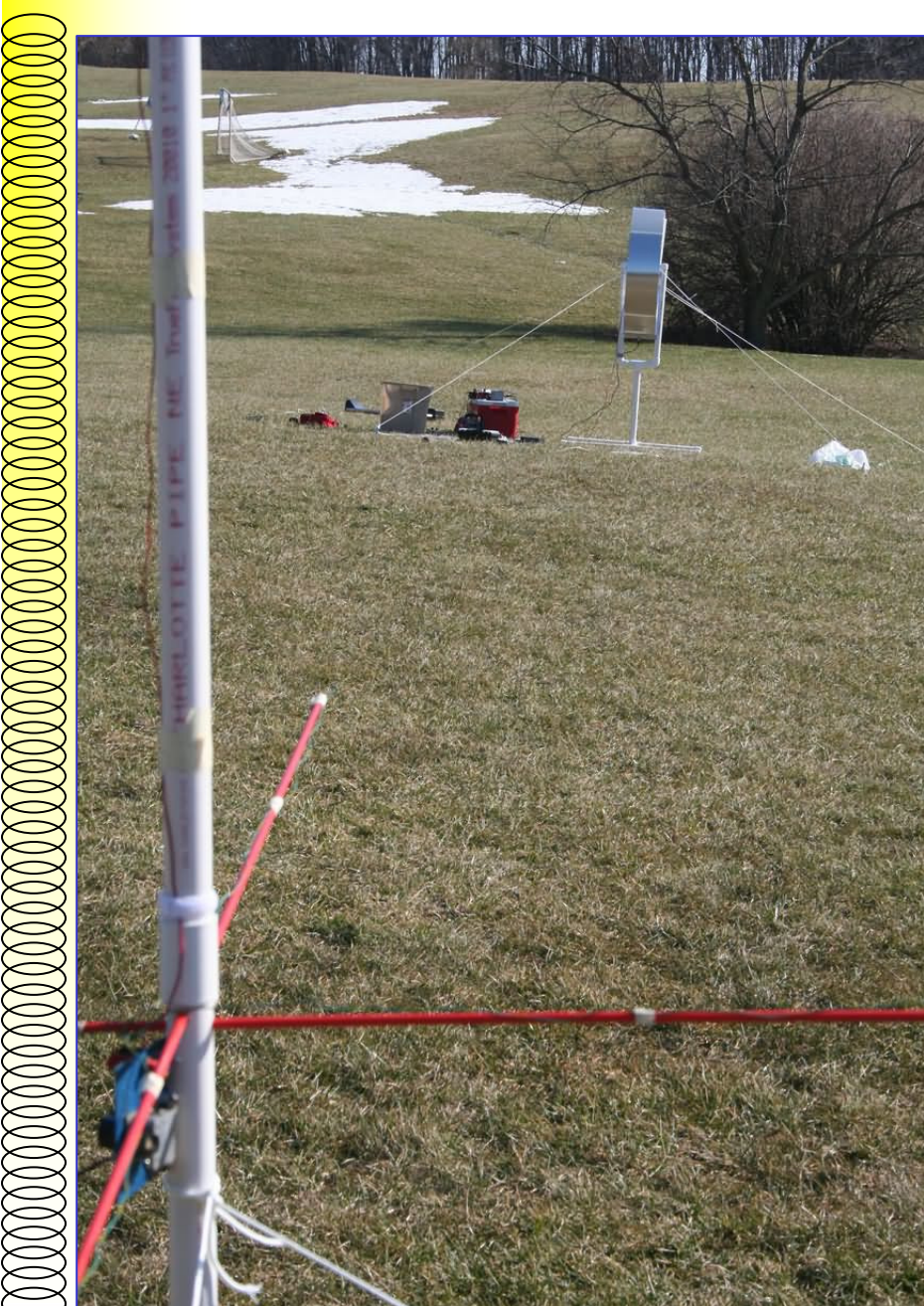

The Midnight Loop

MassCon 2010

*G. Heron N2APB
& J. Everhart, N2GX*

Authors

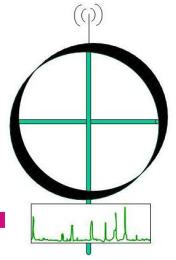

Joe Everhart N2CX



George Heron N2APB